

Motif

CODES

| | | | |
|-------------|-------------|--------------|--------------|
| 432D | 433D | 434D | 435D |
| (Push) | (Push) | (Auto Drive) | (Auto Drive) |

OWNER'S HANDBOOK

(English Version)

CODE FROM SERIAL NO:

432D 260000001

433D 260000001

434D 260000001

435D 260000001

ISSUE 11.11.05

PART NUMBER: 111-0448 (A)

MAIN FEATURES / SPECIFICATIONS

Main Features

1. Spark Plug Lead
2. Fuel Filler Cap.
3. Oil Filler Cap and Dipstick.
4. Handlebar Securing Knob.
5. Rope Guide.
6. Engine Start-Grip.
7. Engine Stop lever.
8. Handlebar.
9. Ground Drive Clutch Lever (Auto drive only).
10. Rear Deflector.
11. Grassbag Assembly.
12. Serial Number Decal.
13. Height of Cut Adjuster.
14. Throttle Control.

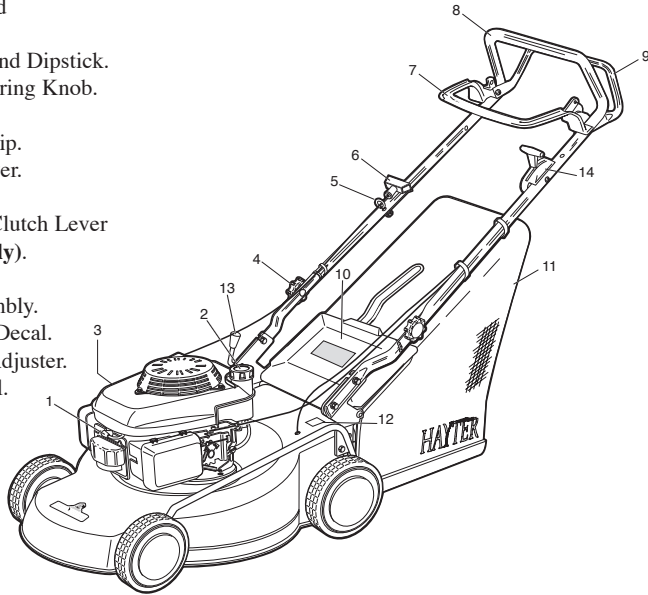

Specifications

| | |
|-------------------------------|--|
| Engine | Honda GCV 135 (Codes 432/433/434) GCV 160 (435) |
| Engine type | GCV135EA2G7 (432/433/434) GCV160EA2G7 (435) |
| Engine/Cutterbar speed | 2900 rpm (432/435) 2700rpm (433/434) |
| Fuel type | Unleaded petrol |
| Fuel capacity | 0.9 litres (432/433/434), 1.1 litres (435) |
| Oil type | SAE 10w-30 engine oil |
| Oil sump capacity | 0.55 litres |
| Cutting width | 410mm (432) 480mm (433/434) 530mm (435) |
| Cutting height | 25 - 55mm |
| Overall dimensions | 1,010 x 490 x 1,395mm (432) 985 x 530 x 1,415mm (433/434) 975 x 570 x 1,500mm (435) |
| Dry Weight | 31Kg (432) 31.8Kg (433) 34Kg (434) 36Kg (435) |

1ST Year (12 months)

We certify that this service has been carried out by an Authorised Hayter Service Dealer

Date: _____



1ST Year (12 months)

Owner's Name: _____

Serial Number: _____

Date: _____



Note for dealer: Please retain this voucher for your records.



2nd Year (24 months)

We certify that this service has been carried out by an Authorised Hayter Service Dealer

Date: _____



2nd Year (24 months)

Owner's Name: _____

Serial Number: _____

Date: _____



Note for dealer: Please retain this voucher for your records.



- 1.2 Main Features/Specifications**
- 1.5 Contents**
- 1.6 Introduction**
- 1.7 Warranty**
- 1.8 - 1.10 Safety Precautions**
 - 1.8 - *Training*
 - 1.8 - 1.9 - *Preparation*
 - 1.9 - 1.10 - *Operation*
 - 1.10 - *Maintenance & Storage*
 - 1.11 - *Safety Symbols*
 - 1.11 - *Control Symbols*
 - 1.12 Assembling the Mower**
 - 1.12 - *Delivery Checklist*
 - 1.12 - *Handlebar*
 - 1.12 - *Grassbag Attachment*
 - 1.13 Before Starting the Mower**
 - 1.13 - *Prevent Engine Damage*
 - 1.13 - *Oil Type*
 - 1.13 - *Check Oil Level*
 - 1.13 - *Fuel Type*
- 1.14 - 1.17 Operating The Mower**
 - 1.14 - *Controls*
 - 1.14 - *Starting Step 1*
 - 1.14 - *Step 2*
 - 1.14 - *Forward Travel*
 - 1.15 - *Turning*
 - 1.15 - *Stopping*
 - 1.15 - *Slopes*
 - 1.15 - *Height of Cut*
 - 1.16 - *Before Mowing*
 - 1.16 - *Grassbag*
 - 1.16 - *Without Grass Collection*
 - 1.16 - *Heavy Growth*
 - 1.17 - *Non-Grassed Areas*
- 1.18 - 1.19 Lawn Care Calendar - Guide Only**
- 1.20 Maintenance Schedule**
 - 1.20 - *Daily*
 - 1.20 - *25 Hrs or Every Season*
 - 1.20 - *50 Hrs or Every Season*
 - 1.20 - *100 Hrs or Every Season*
- 1.21 - 1.27 Mower Maintenance**
 - 1.21 - *Engine*
 - 1.21 - *Carburettor Adjustments*
 - 1.22 - *Oil Service*
 - 1.22 - *Air Cleaner Service*
 - 1.23 - *Spark Plug Service*
 - 1.23 - *Keeping Engine Clean*
 - 1.23 - *Grassbag*
 - 1.24 - *Deck Housing*
 - 1.24 - *Securing Nuts and Bolts*
 - 1.24 - *Clutch Cable Adjustment*
 - 1.25 - *Lubrication*
 - 1.25 - *Cutterblade Removal*
 - 1.26 - *Cutterblade Assembly*
 - 1.26 - *Cutterblade Sharpening*
 - 1.27 - *Storage*
- 1.28 - 1.29 Trouble Shooting**
- 1.30 - 1.32 Parts List**
 - 1.33 Parts list Diagrams**
 - 1.34 Customer Information/Notes**

INTRODUCTION

Thank you for purchasing a **Hayter** mower. The following pages are designed to help you gain safe and efficient service from your machine.

IMPORTANT: This ‘Owners Handbook’ should be regarded as part of the mower as it gives essential information regarding mower safety, operation, maintenance and specifications. Read and understand this handbook prior to operating your mower for the first time. Make sure you are familiar with all the controls and points of regular maintenance. If you have any doubts, consult your local **Hayter** authorised dealer who will be pleased to give you assistance.

IMPORTANT: This mower is designed solely for use in a domestic grass cutting environment. Use in any other way is considered as contrary to the intended use. Compliance with and strict adherence to the conditions of operation, service and repair as specified in this handbook also constitute essential elements of the intended use.

This mower should be operated, serviced and repaired only by persons who are familiar with its particular characteristics and who are acquainted with the relevant safety procedures.

The safety precautions listed in this handbook and all other generally recognised regulations on safety must be observed at all times.

Any arbitrary modifications carried out to this machine may relieve Hayter Limited of liability for any resulting damage or injury.

Hayter mowers are robustly constructed and designed for efficient economical performance under normal mowing conditions. Correct operation and maintenance will ensure a long and satisfactory service life. Prior to despatch from our factory every effort is made to ensure that your mower is delivered in perfect condition.

Throughout this handbook all references to **left** and **right** are as viewed from behind the handlebar, in the direction of forward travel.

This handbook is based on information available at the time of publication.

HAYTER LIMITED reserve the right to amend product specifications without prior notification.

LIMITED WARRANTY

Hayter Limited warrants to the original user/purchaser that this unit shall be free from defects in material and workmanship under normal use and service for a period of **three years** from the date of purchase. The manufacturer of major proprietary components ie. engines, gearbox / transaxle (where applicable) furnish their own warranty and services are provided through their authorised network. To qualify for the full benefit of the warranty, the warranty registration card **must** be returned within **14 days** of purchase. Subject to the conditions and exclusions noted in this limited warranty, we shall at our option, repair or replace any warranted part during the applicable period. If you are in doubt or experience any difficulty, please consult a Hayter Authorised Service Dealer for clarification.

To qualify for the extended warranty (second and third year) of the **three year limited warranty** the machine **must** have annual services carried out by an Authorised Hayter Service Dealer. These chargeable services should be carried out within 12 and 24 months of the date of purchase.

Excluded from the extended warranty period are those items which are subject to normal wear and tear e.g. tyres, wheels, cutterblades, belts, cables, grassbags, sweeper/brushes, batteries and other consumable wearing parts.

All consumer machines which are fitted with a **genuine** Hayter friction disc as original equipment before use, are covered by a **Lifetime Warranty** against the engine crankshaft bending. **Note:** friction washers, blade brake clutch (B.B.C) units and other such devices are not applicable. Only machines fitted with a **genuine** Hayter friction disc, which are used in accordance with the recommended operating and maintenance procedures, are covered.

This warranty does not apply to any unit that has been tampered with, altered, misused, abused or used for hire, and will become invalid if non genuine Hayter parts are fitted. This warranty does not cover minor mechanical adjustments unless they are due to defective material or workmanship. Consult the Owner's Handbook or a Hayter Authorised Service Dealer for assistance when making these adjustments.

A warranty period of 90 days applies to machines used for commercial purposes.

To make a warranty claim, return the unit to a Hayter authorised dealer along with proof of purchase stating the machine serial number and date of purchase. The service receipt(s) or this Owners Handbook with the 1st/2nd year service boxes fully completed, must be produced as proof of entitlement to the extended warranty period. Subject to the conditions and exclusions in this limited warranty, the authorised dealer will, at our option, repair or replace any warranted part within the duration of the warranty period.

This limited warranty gives you specific legal rights and is in addition to any statutory rights to which you may be entitled and your statutory rights are not affected by this warranty. If you need additional information concerning this written warranty, or assistance in obtaining services, please write to : **HAYTER LIMITED, Service Department, Spellbrook, Bishop's Stortford, Hertfordshire CM23 4BU**

UK ONLY: Details of your local **Hayter** authorised dealer are contained in Yellow Pages and the Hayter website www.hayter.co.uk or contact contact:- Freephone 0800 616298.

Safety Alert Symbol



This safety alert symbol indicates important safety messages. When you see this symbol be alert to the possibility of injury. Carefully read the following and inform others.

Your mower is perfectly safe if used correctly. Failure to observe the following precautions may result in serious injury.

Training



Before using the mower read the owners handbook carefully. Pay particular attention to the safety precautions. Ensure that you are familiar with the controls and the proper use of the equipment. Learn how to stop the mower quickly in an emergency.

Never allow children or people unfamiliar with these instructions to use the mower.

Never mow while people, especially children, or pets are nearby.

Keep in mind that the user is responsible for accidents or hazards occurring to other people or their property.

Preparation



While mowing, always wear substantial footwear and long trousers. Do not operate the equipment when barefoot or wearing sandals.

Thoroughly inspect the area where the mower is to be used and remove all objects which may be thrown by the machine.

WARNING: Petrol is highly flammable.

- Store fuel in containers specifically designed for this purpose.
- Refuel outdoors only and do not smoke while refuelling.
- Add fuel before starting the engine. Never remove the cap from the fuel tank or add petrol while the engine is running or when the engine is hot. Allow the engine to cool for at least two minutes before refuelling.
- Do not attempt to start the engine if petrol is spilled or a smell of petrol is present. Move the mower away from the area of spillage and avoid creating any source of ignition until petrol vapours have dissipated.

SAFETY PRECAUTIONS

Preparation

- Always use fresh fuel. Stale fuel can block the carburettor and cause leakage.
- Replace fuel tank and oil tank caps securely.

A damaged cutterblade or loose fixing bolt are major hazards. Before use, always visually inspect the cutting mechanism to ensure that it is in good condition. A damaged cutterblade must be replaced immediately with a genuine Hayter replacement part.



Operation

Do not operate the engine in a confined space where exhaust fumes (carbon monoxide) can collect.

Always pull the starter cord slowly until resistance is felt. Then pull the cord rapidly to avoid kickback and prevent hand or arm injury.

Mow only in daylight or good artificial light.

Avoid using the mower on wet grass, where feasible.

Always be sure of your footing on slopes.

Walk, never run.

Mow across the face of slopes, never up and down.

Exercise extreme caution when changing direction on slopes.

Do not mow excessively steep slopes of more than 20 degrees.

Use extreme caution when reversing or pulling the mower towards you.

Stop the engine before moving the mower across areas other than grass.

Never operate the mower unless all guards are securely in position and in good condition.

Do not change the engine governor settings or overspeed the engine.

Disengage the ground drive clutch lever before starting the engine.
(Autodrive only)

Start the engine carefully, with feet well away from the cutterblade.



SAFETY PRECAUTIONS



Operation

Do not tilt the mower when starting the engine.

Do not put hands or feet near or under rotating parts.

Never pick up or carry the mower while the engine is running.

Never lift the rear deflector while the engine is running.

Never touch the exhaust/exhaust guard or cooling fins when the engine is hot.

Stop the engine and disconnect the spark plug lead:

- Before clearing blockages or unclogging the discharge chute.
- Before cleaning/checking or working on the mower.
- After striking a foreign object. Inspect the mower for damage and ensure necessary repairs are made before re-starting.
- If the mower starts to vibrate abnormally (check immediately).

Stop the engine:

- Whenever you leave the mower.
- Before refuelling.
- Reduce throttle control setting during engine shutdown and turn fuel valve off at the conclusion of mowing.



Maintenance & Storage

Keep all nuts, bolts and screws tight to ensure that the equipment is in safe operating condition.

Frequently check fuel lines and fittings for cracks or leaks and replace if necessary.

Never check for a spark when the spark plug is removed. (Use approved tester)

Inspect the exhaust periodically and replace if worn or leaking.

Never crank the engine with the spark plug removed.

Never start the engine with the air-cleaner or air-cleaner cover removed.

Never store the mower with petrol in the tank within an enclosed area where fumes may reach an open flame or spark.

Allow the engine to cool before storing in any enclosure. To reduce the fire hazard, keep the engine and the surrounding deck area free of grass, leaves, or excessive grease.

SAFETY PRECAUTIONS

Maintenance & Storage

Check the rear deflector and grassbag frequently for wear or deterioration. Replace worn or damaged parts for safety.

If the fuel tank has to be drained, this should be done outdoors and when the engine is cool.

Wear strong work gloves when removing and reassembling the cutterblade.

Always replace worn or faulty parts with genuine Hayter parts.



Safety Symbols

Petrol Engine Safety Symbols

Stop engine and remove power cable and sparkplug before working on the mower.

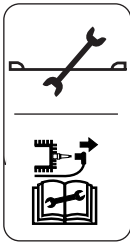

General Safety Symbols

Safety Alert -
Be aware of the possibility of injury.



Carefully read the Owners Handbook before using themachine.

Safety Alert -
Be aware of the possibility of injury.



Danger of severing toes or fingers in cutting mechanism.

Danger of being hit by thrown objects.



Keep bystanders at a safe distance from the mower.

Electrical Safety Symbols

Stop engine and remove power cable before working on the mower.

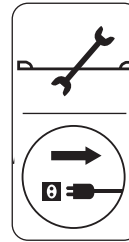

Danger of severing electrical cables in cutting mechanism..

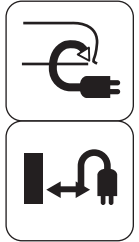

Keep bystanders at a safe distance from the mower.

Control Symbols

Height of Cut Adjustment



Engine Stop



Throttle Control

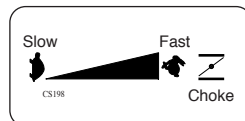

ASSEMBLING THE MOWER

Delivery Checklist

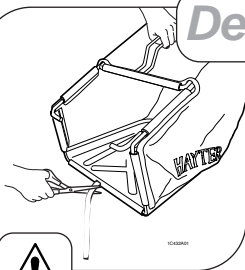

Remove the mower from the packaging and check that the following items have been supplied correctly. If any items are missing contact your local Hayter dealer.

1. Engine Handbook.
2. Grassbag

To prevent accidents cut off the long ribbon attached to the grassbag and discard.

Handlebar

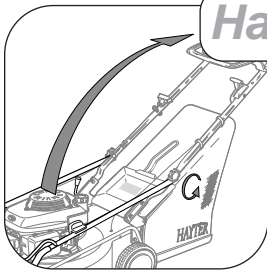

Unscrew the handlebar securing knobs sufficiently to allow the handlebar to pivot. Unfold the handlebar to the operating position. Tighten both handlebar knobs to secure the handlebar in position.

Take care to ensure that the control cables do not become snagged at the pivot point.

Grassbag Attachment

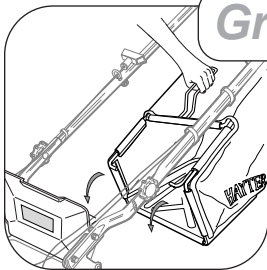

Raise the rear deflector, lower the grassbag through the handlebar and hook in position. Lower the deflector to rest on the grassbag.

BEFORE STARTING THE MOWER

Prevent Engine Damage

To prevent engine damage the engine is shipped without oil or petrol. The engine must be filled with the correct grade of oil and petrol before starting the engine.



Oil Type

Always use high quality detergent oil classified SAE 10W 30 Oil. Never use additives with this oil. To prolong the life of your engine it is important that the oil is changed after the first 5 hours of use - refer to 'Maintenance Schedule'.

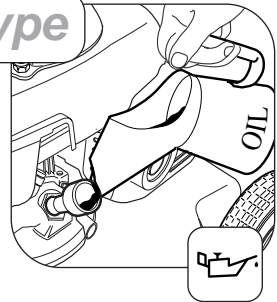

Check Oil Level

Clean around the oil filler cap before removing. With the mower on a level surface, unscrew and remove the oil filler - dipstick. Wipe oil from it with a clean cloth. Insert the dipstick back in the oil filler neck but do not screw it in. Remove the dipstick and check the oil level.

The oil level is correct when it is at the **full** mark on the dipstick. **DO NOT OVERFILL.**

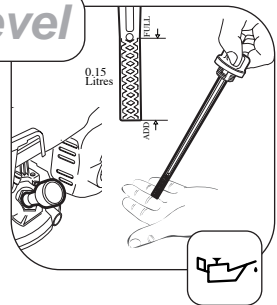

Fuel Type

Always use clean, fresh unleaded petrol. Purchase fuel in quantities that can be used within 30 days. Never mix oil with petrol. For added engine protection Honda recommend the use of their fuel additive which is available from an authorised Honda service dealer.

Fill to base of neck to allow for fuel expansion. Do not overfill the fuel tank.

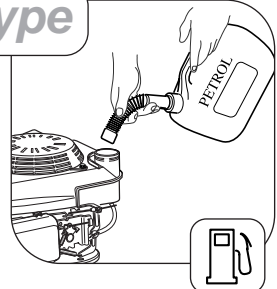

OPERATING THE MOWER

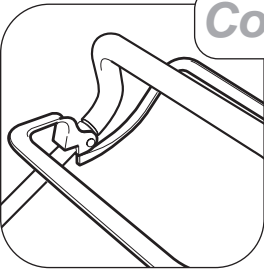

Controls

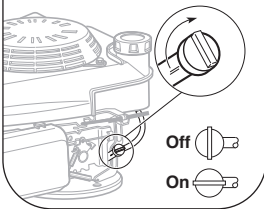

Operate all control levers several times and ensure that the cables move freely. Check that the engine stop and (ground drive clutch levers - **Autodrive models**) return freely to their rest position when released.

Starting - Step 1



Turn the fuel valve to the on position. Move the throttle control lever to the 'choke'  position before starting a cold engine. Move the throttle control lever to the 'fast'  position before starting a warm engine.

Step 2

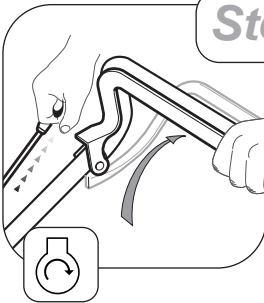

Stand behind the mower and hold the handlebar with your left hand together with the engine stop lever. With your right hand hold the engine start - grip and pull slowly until resistance is felt, then pull rapidly to crank the engine. Carefully return the start grip to the storage position when the engine starts.

When the engine warms up move the control lever to the fast position.

If the engine does not start after 5 attempts - refer to "Trouble Shooting".

Forward Travel

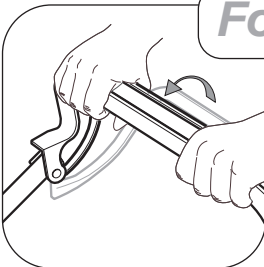

Push Models - Hold and push against the handlebar with both hands to move the mower forward.

Autodrive models - Hold the handlebar and operate the ground drive clutch lever to power the mower in a forward direction. When the ground drive clutch lever is disengaged the mower may be pushed. This feature is useful when mowing in confined areas.

If the engine stop lever is released the engine will stop.

OPERATING THE MOWER

Turning

To make a wide turn steer the mower with the handlebar in the direction required.

To make a tight turn (release the ground drive clutch lever, **Autodrive model**), apply downward pressure on the handlebar to raise the front wheels just above ground level and steer in the required direction.

To prevent accidents do not raise the front of the mower excessively when making a turn. Never raise the rear of the mower when the engine is running.



Stopping

Release the engine stop lever and ground drive clutch lever on auto drive models and push the throttle control lever to the 'slow'  position.

Emergency stop - If the engine fails to stop, disconnect the spark plug lead.

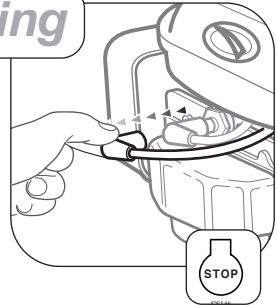

Slopes

To prevent engine damage do not use the mower on slopes greater than 20 degrees.

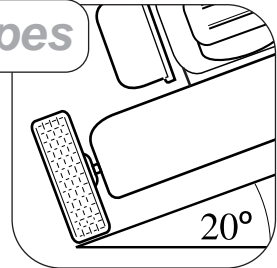

Height of Cut

Move the height of cut lever sideways to disengage it from the locking notch, then push forwards to raise or pull backwards to lower the height of cut. Release the lever in the required position and ensure that it locks firmly into one of the eight notch settings.

Always select a height of cut to suit operating conditions. Prevent engine overloading and blockages by avoiding low cuts in long grass conditions. Be prepared to make two cuts when the grass is long.

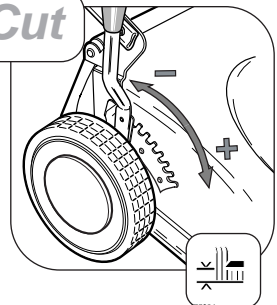

OPERATING THE MOWER

Before Mowing



To prevent accidents thoroughly inspect the area and remove all objects which when contacted by the cutterblade could become dangerous projectiles. Inspect the area for hidden obstructions which when contacted by the cutterblade could risk health and safety or result in damage to the mower. Remember the location of these obstructions and ensure that you mow around them.



Grassbag

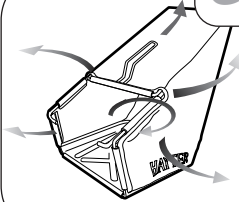

Lift the grassbag through the handlebar and close the rear deflector to rest against the rear of the mower.

To empty the grassbag, pour out the grass clippings and shake the grassbag vigorously to clean the airways. Good grass collection depends on good air flow through the grassbag. When collecting grass clippings it is important that the grassbag is emptied regularly to prevent blockages and engine overloading.

Without Grass Collection

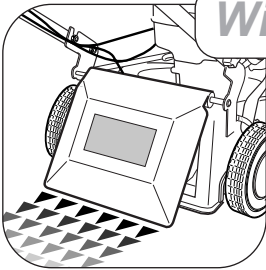

Remove the grassbag and operate the mower with the rear deflector in the closed position.

Heavy Growth

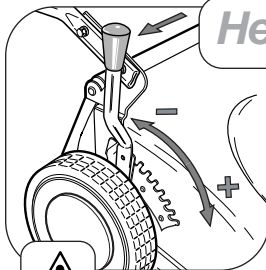

To prevent engine overloading and blockages be prepared to make two cuts in areas of heavy growth. If collection is required, first mow the area at the maximum height of cut setting with the grassbag fitted. Reduce the height of cut and mow the area again as necessary until the required finish is obtained.



To prevent damage to your lawn do not remove more than one third of grass height in one cut.

OPERATING THE MOWER

Non-Grassed Areas

When moving the mower across non-grassed areas, stop the engine by releasing the engine stop lever and set the mower to the maximum height of cut to protect the cutting mechanism.



LAWN CARE CALENDAR

To be used as a guide only.

January

There is very little work to do this month apart from brushing away leaves. Keep off the grass if frozen or waterlogged.

February

Rake the grass thoroughly. Spike the lawn to aerate and stimulate soil organisms and root growth and apply lawn sand if necessary.

March

The yearly lawn work programme really starts this month. As soon as the ground conditions are suitable, the first cut can be made. The first cut should merely "top" the grass as close cutting at this stage could result in severe yellowing or browning. Two cuts are generally sufficient this month.

April

Mow often enough to stop grass growing away. Dig out patches of coarse grass or resistant weed. Re-seed bare patches.

May

Keep mowing increasing the frequency as required. Treat with selective weed killers or combined weed/feed preparations if you did not feed the lawn in April.

June

Summer mowing should now be under way. It should be necessary to mow the lawn twice a week. Raking before mowing is important this month as the combined action keeps runners of clover under control. Water the grass if necessary, and remember to soak thoroughly.

July

Treat the grass with the second application of fertiliser or weed killer/fertiliser. Water when necessary and rake occasionally. As a general rule the grass clippings should be removed each time you mow. If weather conditions are dry and hot and the grass is weed free, leave the clippings on the lawn to help maintain ground moisture.

LAWN CARE CALENDAR

August

Keep mowing regularly and watering as necessary. Fill any cracks caused by drought with a mixture of sharp sand and soil. In dry weather conditions leave the grass longer to help retain ground moisture.

September

Raise the height of cut to allow the grass to thicken and protect the roots from the winter frost and snow.

October

Rake out the thatch from the turf and spike the lawn to assist in drainage. Brush in peat and sharp sand.

November

Use a stiff broom to disperse worm casts before mowing. Keep turf free from leaves.

December

Apart from brushing away leaves, December is a slack end of a busy year. Keep off the lawn if it is very wet or frozen.

To prevent grass damage do not remove more than one third of the grass height in one cut.

MAINTENANCE SCHEDULE

Follow the hourly or calendar intervals, whichever occurs first. More frequent service will be required if working for prolonged periods under dusty, dry conditions, or when airborne debris is present or after extensive operation cutting tall, dry grass.

- After the very first five hours change the engine oil

Daily

- Check the oil level
- Remove grass debris from around the engine, exhaust/exhaust guard, air ways in the top cowl and underside of the deck housing.
- Remove grass debris from the grassbag and check for signs of damage.
- Check the condition of guards and safety devices.
- Check condition of cutterblade.

25Hrs or Every Season

- Change the engine oil if continuously operating under heavy load or high ambient temperature.
- Service the air cleaner.
- Lubricate wheels, pivot points and linkages and grease the inner control cables at point of entry and exit from their outer casing.
- Check the clutch cable adjustment. (**Autodrive Model**)
- Sharpen the cutterblade.

50Hrs or Every Season

- Change the engine oil.

100Hrs or Every Season

- Clean the engine cooling system. Clean more often under dusty conditions or when airborne debris is present or after prolonged operation whilst cutting tall, dry grass.
- Replace the spark plug.

MOWER MAINTENANCE

To prevent accidents stop the engine disconnect the spark plug lead before attempting to carry out maintenance procedures on the mower.



Engine

1. Finger Guard
2. Carburettor
3. Spark Plug / Lead
4. Exhaust Guard
5. Exhaust
6. Oil filler Cap/ Dipstick
7. Start Grip
8. Fuel Cap
9. Air cleaner.

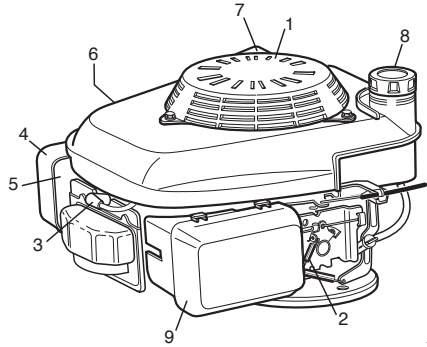

Carburettor Adjustments

Should only be made by an authorised Honda dealer. Under no circumstances should the engine be adjusted to run at a speed in excess of that shown on the Declaration of Conformity.

MOWER MAINTENANCE

Oil Service

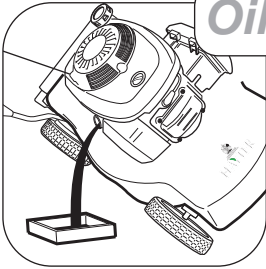

Check the oil level daily before starting the engine and ensure that the correct oil level is maintained. Refer to-‘Before Starting the Mower’ for oil checking and filling instructions.

Change the engine oil after the first 5 hours of operation and thereafter according to the ‘Maintenance Schedule’:-

1. Drain fuel by running the engine until the fuel tank is empty.
2. Remove the spark plug lead.
3. Allow the engine to cool.
4. Drain the oil while the engine is warm.(Not hot)
5. Tip the mower over on to its right hand side thus ensuring that the air cleaner is kept uppermost **to prevent engine damage.**
6. Remove the oil filler dipstick and drain the oil into a suitable container.
7. Refill with new oil of the recommended SAE viscosity grade. (Refer to-‘Before Starting the Mower’)

Air Cleaner Service

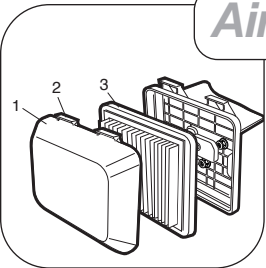

To service the air cleaner remove the air cleaner cover (1) by releasing two top catches (2) and tilting away from body until lower tabs release. Remove cartridge (3) and clean by tapping gently on a flat surface. If very dirty or damaged replace.

- Do not brush
- Do not use petroleum solvents.
- Do not oil the cartridge.

After servicing, install the cartridge in the cover. Insert the tabs on the bottom of the cover into the slots in the bottom of the base. Tilt the cover upwards until the two catches (2) hold it in place.

MOWER MAINTENANCE

Spark Plug Service

Use only an approved spark tester (1) to check for a spark as shown in the diagram.

Replace the spark plug every 100 hours or every season, whichever occurs first. A spark plug wrench is available from any authorised Honda service dealer.

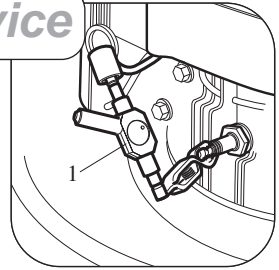

Check the spark plug gap with a feeler gauge and set at 0.7 - 0.8mm.

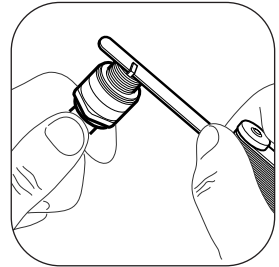

Keeping Engine Clean

Remove all grass and debris from the engine including the exhaust/exhaust guard, the air ways in the top cowl and the surrounding deck areas on a daily basis after use. Never spray the engine with water during cleaning. Water can contaminate the fuel. Always clean with a brush or compressed air.

Grass and debris may clog the engine's air cooling system especially after prolonged operation while cutting tall, dry grass. The internal cooling fins and surfaces may require cleaning to prevent overheating and engine damage. We recommend that this service be carried out by an authorised Honda dealer.

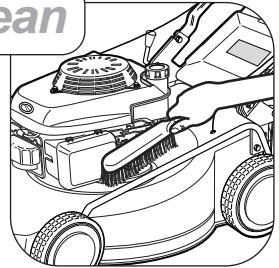

Grassbag

Remove grass debris from the grassbag immediately after use and check its condition for signs of damage.

To prevent accidents replace a damaged grassbag immediately.



MOWER MAINTENANCE

Deck Housing

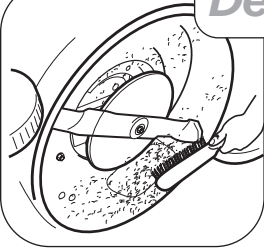

Remove grass debris from the top and underside of the deck housing immediately after use.

Fertilisers and top dressings are particularly corrosive. Thoroughly clean the mower deck immediately after use on treated grass and store well away from corrosive materials.

Securing Nuts & Bolts



Regularly check that all securing nuts and bolts are tight. Replace missing or damaged items immediately.

Clutch Cable Adjustment

32-38mm

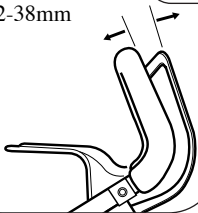

Autodrive Models - Check the clutch cable operation every 25 operating hours and adjust if necessary. The clutch cable is adjusted correctly when the belt drive just engages with the clutch lever positioned 32-38mm from the handlebar.

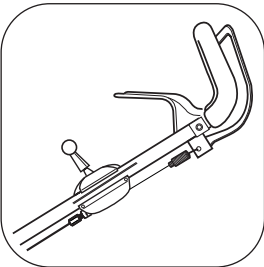

Unscrew the locknuts and screw the adjuster in or out as necessary. Tighten the locknuts when correctly.

MOWER MAINTENANCE

Lubrication

Lubricate the wheels, pivot points and linkages with engine oil every 25 operating hours.

Apply a good quality medium grease to the inner control cables at the point of entry and exit from their outer casing.

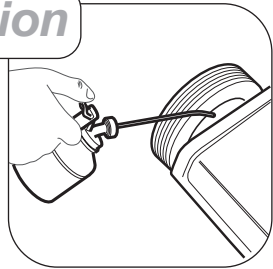

Cutterblade Removal

Drain the fuel by running the engine until the fuel tank is empty and the engine stops. **Remove the spark plug lead** and allow the engine to cool. Turn the mower on its right hand side and ensure that the air cleaner side of the engine is uppermost.

Firmly grip the end of the cutterblade with the gloved hand and remove the bolt securing the cutterblade.

To prevent accidents never work on the cutterblade unless the spark plug lead has been removed. The cutterblade has sharp edges. ALWAYS wear strong gloves to protect your hands when working on the cutterblade. DO NOT rotate tools towards the cutting edges to avoid the risk of injury should the tool slip. ALWAYS use genuine Hayter replacement parts.

The condition of the cutterblade and its mounting arrangement should be checked regularly for signs of wear or damage. Ensure that the cutterblade is not bent or cracked.

A damaged cutterblade that is out of balance will vibrate excessively and may break. **DO NOT** use an unbalanced cutterblade.

Regularly check that the bolt securing the cutterblade is tightened to the specified torque of 54Nm.

Replace the cutterblade every 2 years or sooner if excessively worn or damaged.

To prevent injury it is wise to seek assistance when turning the mower on its side.

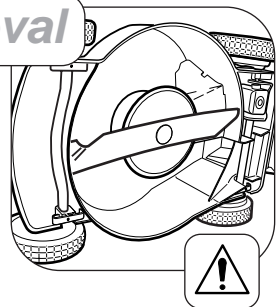

MOWER MAINTENANCE

Cutterblade Assembly

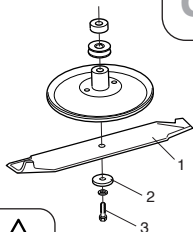

Assemble the cutterblade (1) with the turned up edges facing towards the engine. Secure the cutterblade using the friction washer (2) and new fixing bolt (3) and tighten to a torque of 54Nm.

To prevent accidents never reuse the original fixing bolt.



Cutterblade Sharpening

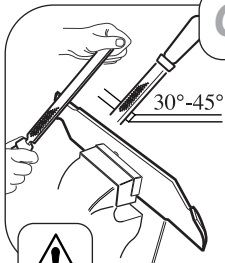

A slightly worn cutterblade may be re-sharpened. Both blade edges must be sharpened equally to ensure balance. Sharpen the cutterblade every 25 mowing hours or more frequently if conditions require. Remove the cutterblade from the mower and clean using a brush and water. Inspect the cutterblade for signs of damage. Sharpen both cutting edges with a flat file to restore performance.



Ensure that the cutterblade is balanced. Use a screw driver with a round shaft to support the cutterblade through its centre hole. Hold the cutterblade horizontal and then release. A balanced cutterblade will remain horizontal.



If the cutterblade is not balanced the heavy end will rotate downwards. Sharpen the heavy end until the cutterblade is correctly balanced.

MOWER MAINTENANCE

Storage

To store the handlebar unscrew the 2 small securing knobs sufficiently to allow it to pivot forwards to rest against the mower. Take care to ensure that the control cables do not become snagged at the pivot point and depress the engine stop lever to prevent it being damaged through contact with the engine.

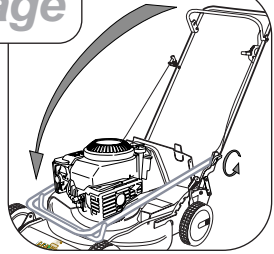

Engines stored in excess of 30 days need to be protected with Honda fuel additive or drained of fuel to prevent gum from forming in the fuel system or on essential carburettor parts. To ensure your mower is maintained in good working order it is important that the following procedure is adopted. Refer to the Maintenance section as necessary.

Drain fuel from the engine by operating the engine until it stops and drain fuel from carburettor using drain plug (1) located on carburettor bowl.



Disconnect the spark plug lead.

Change the engine oil.

Pull the starter rope gently until resistance is felt. This will close the valves and prevent corrosion and ingress of dirt.

Clean grass and debris from the engine cylinder, cylinder head cooling fins, under top cowl, and around and behind exhaust/exhaust guard.

Clean all other areas of the mower and ensure that the grassbag is clean.

Lubricate the mower.

Treat metal parts with a water repellent anti-corrosion product.

Cover the mower with a protective sheet and store it in a dry, ventilated area.

TROUBLE SHOOTING

| PROBLEM | POSSIBLE FAULT | REMEDY |
|---------------------------|---|---|
| Engine will not turn over | Incorrect oil level. | Check oil level. |
| | Obstruction under deck. | Remove obstruction. |
| Engine smokes | Excess oil level. | Check oil level. |
| | Air cleaner cartridge oil soaked or blocked. | Service air cleaner. |
| Engine runs then stops | Fuel starvation. | Fill fuel tank. |
| | Fuel valve off. | Turn to on Position. |
| | Fuel cap vent blocked. | Clean fuel cap vent. |
| Engine will not start | Engine brake on | Release engine brake. |
| | Engine under load. | Raise height of cut. |
| | Fuel starvation. | Fill fuel tank. |
| | Fuel valve off. | Turn to on Position. |
| | Engine cold. | Put throttle to choke position. |
| | Incorrect/contaminated fuel. | Drain fuel tank and fill with correct fuel. |
| | Spark plug lead disconnected. | Connect spark plug lead. |
| | Faulty spark plug. | Clean and adjust gap or replace. |
| Wiring fault. | Check wiring. | |
| Engine runs rough | Spark plug lead becoming disconnected in use. | Connect spark plug lead. |
| | Faulty spark plug. | Clean and adjust gap or replace. |
| | Air cleaner blocked. | Service air cleaner. |
| | Incorrect/contaminated fuel. | Drain tank and fill with correct fuel. |

TROUBLE SHOOTING

| PROBLEM | POSSIBLE FAULT | REMEDY |
|---|---|--|
| Engine vibrates excessively | Mounting bolts loose. Cutterblade bolt loose. Cutterblade out of balance. Bent crankshaft. | Tighten bolts Tighten bolt Balance cutterblade Consult your dealer |
| Uneven cut | Undulating ground conditions Cutterblade worn Cutterblade out of balance Wheels | Change direction of travel Sharpen the cutterblade Balance the cutterblade Inspect and replace as necessary |
| Discharge chute blocks | Grass is wet Cut height too low Grassbag full Airflow through the grassbag is restricted | Mow dry grass Increase cut height Empty grassbag Clean the grassbag |
| Mower is hard to push | Cut height too low Wheels damaged | Increase cut height Inspect and replace as necessary |
| Mower will not self propel (Autodrive Model) | Clutch out of adjustment Drive belt damaged | Adjust clutch cable Replace drive belt |
| Poor grass collection | Airflow through the grassbag is restricted Discharge chute blocked Wet grass Grassbag full | Clean the grassbag Remove blockage Mow dry grass Empty grassbag |

EC DECLARATION OF CONFORMITY

Manufacturer: HAYTER LIMITED,
Address: Spellbrook, Bishop's Stortford, Herts. CM23 4BU. ENGLAND



declare that the lawnmower:

| | | | | |
|--|-------------------|-------------------|-----------------------|-----------------------|
| Model name: | Motif 41 Push | Motif 48 Push | Motif 48 Autodrive | Motif 53 Autodrive |
| Type: | Pedestrian rotary | Pedestrian rotary | Pedestrian rotary | Pedestrian rotary |
| Model No: | CODE 432D | CODE 433D | CODE 434D | CODE 435D |
| Cutting width: | 410mm | 480mm | 480mm | 530mm |
| Speed of rotation of the cutting device: | 2900 rpm | 2700 rpm | 2700 rpm | 2900 rpm |
| Engine manufacturer: | Honda | Honda | Honda | Honda |
| Speed of rotation of engine: | 2900 rpm | 2700 rpm | 2700 rpm | 2900 rpm |

Complies with the provisions of Directive: 98/37/EC Essential Health & Safety Requirements Relating to the Design & Construction of Machinery and Safety Components, as amended and the regulations transposed into national law.

Also Directive 89/336/EEC Electromagnetic Compatibility, as amended and the regulations transposed into national law.

Also Directive 2000/14/EC Noise emission in the environment by equipment for use outdoors and the regulations transposed into national law.

Procedure applied for the conformity assessment: ANNEX VI, procedure 1.

Notified Body: Sound Research Laboratories Ltd. Holbrook House, Little Waldingfield, Sudbury, Suffolk. CO10 0TH. ENGLAND

Notified body identification No: 1088

| | | | | |
|-------------------------------|----------|----------|----------|-----------|
| Measured sound power level: | 95 dB(A) | 95 dB(A) | 95 dB(A) | 97 dB(A) |
| Guaranteed sound power level: | 96 dB(A) | 96 dB(A) | 96 dB(A) | 100 dB(A) |

Complies with harmonized standards: EN 292, EN 836 and EN ISO 14982

Signed

S.A Maryniak
(Technical Director)

Date: 26.11.04

Declaration done and technical documentation kept at:
HAYTER LIMITED
Spellbrook, Bishop's Stortford,
Herts. CM23 4BU ENGLAND

VIBRATION INFORMATION

The vibration level at the operator contact positions, measured in accordance with European Standard EN 836

CODE432D - 4.3ms⁻² CODE433D - 3.5ms⁻² CODE434D - 4.4ms⁻² CODE435D - 7.7ms⁻²

PARTS LIST

| NO. | DESCRIPTION | PART NO. | QTY | | | | ITEM NOTE |
|-----|----------------------------|-------------|-----|-----|-----|-----|-----------|
| | | | 432 | 433 | 434 | 435 | |
| 1 | Washer - 12mm Thin | HY09485 | 1 | 0 | 0 | 0 | |
| 2 | Engine - | HY432004 | 1 | 1 | 1 | 0 | |
| | Engine | 435004 | 0 | 0 | 0 | 1 | |
| 3 | Decal - Engine | HY432009 | 1 | 0 | 0 | 0 | |
| | Decal - Engine | 433009 | 0 | 1 | 1 | 0 | |
| | Decal - Engine | 435009 | 0 | 0 | 0 | 1 | |
| 4 | Cable Engine Brake | HY412007 | 1 | 1 | 1 | 1 | |
| 5 | Control Throttle | HY432006 | 1 | 1 | 1 | 1 | |
| 6 | Knob - Handlebar | 480088 | 2 | 2 | 2 | 2 | |
| 7 | Plug - Handlebar | 300160 | 2 | 2 | 2 | 2 | |
| 8 | Bolt - Saddle | HY226024 | 2 | 2 | 2 | 2 | |
| 9 | Nut - Nyloc M6 'P' Type | 09544 | 1 | 1 | 1 | 1 | |
| 10 | Washer - Plain M6. | 09472 | 1 | 1 | 1 | 1 | |
| 11 | Guide - Rope. | 305093 | 1 | 1 | 1 | 1 | |
| 12 | Handlebar - Upper | 305145W | 1 | 1 | 1 | 1 | |
| 13 | Plug - Drive Large | 341033 | 3 | 3 | 3 | 3 | |
| 14 | Pin - Pivot. | 340182 | 2 | 2 | 2 | 2 | |
| 15 | Lever - Engine Stop. | 340179 | 1 | 1 | 1 | 1 | |
| 16 | Screw - 6 x 20 | 09687 | 2 | 2 | 2 | 2 | |
| 17 | Lever - Clutch | 306094W | 0 | 0 | 1 | 1 | |
| 18 | Fastener - Drive. | 300144 | 4 | 4 | 4 | 4 | |
| 19 | Washer - Nylon. | 09688 | 6 | 6 | 2 | 2 | |
| 20 | Nut - M6 Nyloc 'T' Type | 09438 | 3 | 3 | 3 | 3 | |
| 21 | Screw - M6 x 55 | 09780 | 1 | 1 | 1 | 1 | |
| 22 | Guide - Cable | 410037 | 2 | 2 | 2 | 2 | |
| 23 | Cable Tie. | HY3966 | 1 | 1 | 1 | 1 | |
| 24 | Decal - Rear Deflector | 219189 | 1 | 1 | 1 | 1 | |
| 25 | Handlebar - Lower | 432001W | 2 | 2 | 2 | 2 | |
| 26 | Screw - M8 x 20 | 09368 | 8 | 8 | 8 | 8 | |
| 27 | Nut - M8 Nyloc 'T' Type | 09441 | 4 | 4 | 4 | 4 | |
| 28 | Washer - M8 | 09475 | 4 | 4 | 4 | 4 | |
| 29 | Decal - Height of Cut. | 320006 | 1 | 1 | 1 | 1 | |
| 30 | Spring - Rear Deflector RH | 100.000.826 | 1 | 1 | 1 | 1 | |
| 31 | Spring - Rear Deflector LH | 100.000.825 | 1 | 1 | 1 | 1 | |
| 32 | Deflector - Rear. | 100.000.075 | 1 | 0 | 0 | 0 | |
| | Deflector - Rear. | 100.000.077 | 0 | 1 | 1 | 1 | |
| 33 | Frame - Grassbag | 432010W | 1 | 0 | 0 | 0 | |
| | Frame - Grassbag | 433010W | 0 | 1 | 1 | 1 | |
| 34 | Fabric - Grassbag | HY432003 | 1 | 0 | 0 | 0 | |
| | Fabric - Grassbag | 433003 | 0 | 1 | 1 | 1 | |
| 35 | Screw - M5 x 12 Taptite | 10-11-029 | 2 | 2 | 2 | 2 | |
| 36 | Plate - Discharge | 432021W | 1 | 1 | 1 | 1 | |
| 37 | End Cap - M8 Starlux | 100.000.967 | 2 | 2 | 2 | 2 | |
| 38 | Pin - Deflector | 432007 | 1 | 0 | 0 | 0 | |
| | Pin - Deflector | 433007 | 0 | 1 | 1 | 1 | |
| 39 | Washer - 5/16 | 09270 | 4 | 4 | 4 | 4 | |
| 40 | Bracket - Handlebar LH | 432022W | 1 | 0 | 0 | 0 | |
| | Bracket - Handlebar LH | 433017W | 0 | 1 | 1 | 0 | |
| | Bracket - Handlebar LH | 435017W | 0 | 0 | 0 | 1 | |

PARTS LIST

| NO. | DESCRIPTION | PART NO. | QTY | | | | ITEM NOTE |
|-----|---|-------------|-----|-----|-----|-----|-----------|
| | | | 432 | 433 | 434 | 435 | |
| 41 | Bracket - Handlebar RH | 432023W | 1 | 0 | 0 | 0 | |
| | Bracket - Handlebar RH | 433018W | 0 | 1 | 1 | 0 | |
| | Bracket - Handlebar RH | 435018W | 0 | 0 | 0 | 1 | |
| 42 | Nut - Rivet | 100.004.493 | 4 | 4 | 4 | 4 | |
| 43 | Key | 1662 | 1 | 1 | 1 | 1 | |
| 44 | Clip - Belt Cover | 100.000.801 | 0 | 2 | 2 | 2 | |
| 45 | Cover - Belt | 100.000.800 | 0 | 1 | 1 | 0 | |
| | Cover - Belt | 100.024.883 | 0 | 0 | 0 | 1 | |
| 46 | Knob - HOC | 100.000.828 | 1 | 1 | 1 | 1 | |
| 47 | Connecting Rod 41 | 432005W | 1 | 0 | 0 | 0 | |
| | Connecting Rod 48 | 433011W | 0 | 1 | 0 | 0 | |
| | Connecting Rod 48 | 434003W | 0 | 0 | 1 | 0 | |
| | Connecting Rod 53 | 435014W | 0 | 0 | 0 | 1 | |
| 48 | Axle - Rear 41 | 432027W | 1 | 0 | 0 | 0 | |
| | Axle - Rear 48 | 433016W | 0 | 1 | 0 | 0 | |
| | Axle - Rear 48 RH | 434014W | 0 | 0 | 1 | 0 | |
| | Axle - Rear 53 RH | 434011W | 0 | 0 | 0 | 1 | |
| | Axle - Rear 48/53 LH | 434015W | 0 | 0 | 1 | 1 | |
| 49 | Wheel - Rear 200mm | 100.000.401 | 2 | 2 | 0 | 0 | |
| | Wheel - Rear 200mm | 100.000.403 | 0 | 0 | 2 | 2 | |
| 50 | Nut - M12 Nyloc | 100.000.604 | 4 | 4 | 4 | 4 | |
| 51 | Trim - Front Wheel 180mm | 100.033.691 | 2 | 2 | 2 | 2 | |
| 52 | Wheel - Front 180mm | 100.022.836 | 2 | 2 | 2 | 2 | |
| 53 | Spacer - Axle | 100.000.792 | 4 | 4 | 2 | 2 | |
| 54 | Retainer - Axle | 100.000.897 | 4 | 4 | 4 | 4 | |
| 55 | Screw - Shoulder M6 x 6 | 100.000.576 | 2 | 2 | 2 | 2 | |
| 56 | Bolt - UNF 3/8 x 2.25 | 09122 | 1 | 1 | 1 | 1 | |
| 57 | Washer - Spring 3/8 | 09273 | 1 | 1 | 1 | 1 | |
| 58 | Distance Piece Cutterbar | HY4014 | 1 | 1 | 1 | 1 | |
| 59 | Washer - M6 | 100.000.630 | 2 | 2 | 2 | 2 | |
| 60 | Ratchet Plate - HOC | 432020W | 1 | 1 | 1 | 1 | |
| 61 | Axle - Front | 432019W | 1 | 0 | 0 | 0 | |
| | Axle - Front | 433014W | 0 | 1 | 1 | 0 | |
| | Axle - Front | 435013W | 0 | 0 | 0 | 1 | |
| 62 | Cutterbar 16" | HY201026 | 1 | 0 | 0 | 0 | |
| | Cutterbar 19" | 480149 | 0 | 1 | 1 | 0 | |
| | Cutterbar 21" | 435005 | 0 | 0 | 0 | 1 | |
| 63 | Friction Disc | 480070W | 1 | 0 | 0 | 0 | |
| | Friction Disc | 397042W | 0 | 1 | 1 | 1 | |
| 64 | Spacer | 321034 | 1 | 0 | 0 | 0 | |
| | Spacer $\phi 12 \times \phi 20 \times 17$ | 434005 | 0 | 1 | 1 | 1 | |
| 65 | Deck - Mainframe 41 | 432018V | 1 | 0 | 0 | 0 | |
| | Deck - Mainframe 48 | 433006V | 0 | 1 | 1 | 0 | |
| | Deck - Mainframe 53 | 435007V | 0 | 0 | 0 | 1 | |
| 66 | Screw - Taptite 3/8 x 1/4 UNC | 09349 | 3 | 3 | 3 | 4 | |

PARTS LIST

| NO. | DESCRIPTION | PART NO. | QTY | | | | ITEM NOTE |
|-----|--------------------------|-------------|-----|-----|-----|-----|-----------|
| | | | 432 | 433 | 434 | 435 | |
| 67 | Axle Support | 100.000.895 | 4 | 4 | 4 | 4 | |
| 68 | Decal - Hayter | 410087 | 1 | 1 | 1 | 1 | |
| 69 | Trim - Rear Wheel 200mm | 100.033.711 | 2 | 2 | 2 | 2 | |
| 70 | Cable - Clutch A/D | 434002 | 0 | 0 | 1 | 1 | |
| 71 | Belt Drive | 100.004.594 | 0 | 0 | 1 | 0 | |
| | Belt Drive | 100.014.919 | 0 | 0 | 0 | 1 | |
| 72 | Spring - Tension Gearbox | 100.000.819 | 0 | 0 | 1 | 1 | |
| 73 | Gearbox 48 | 100.004.615 | 0 | 0 | 1 | 0 | |
| | Gearbox 53 | 100.004.816 | 0 | 0 | 0 | 1 | |
| 74 | Bush - Flanged | 100.000.886 | 0 | 0 | 3 | 3 | |
| 75 | Washer | 100.000.634 | 0 | 0 | 2 | 2 | |
| 76 | Gear Drive Assembly LH | 110.002.454 | 0 | 0 | 1 | 1 | |
| 77 | Gear Drive Assembly RH | 110.002.455 | 0 | 0 | 1 | 1 | |
| 78 | Washer 13mm Dia. | 100.000.621 | 0 | 0 | 1 | 1 | |
| 79 | Setscrew - M6 x 12 | 09546 | 0 | 0 | 2 | 2 | |
| 80 | Washer - M6 | 100.000.965 | 0 | 0 | 2 | 2 | |
| 81 | Pulley Drive | 434001 | 0 | 0 | 1 | 1 | |
| 82 | Grubscrew - M6 x 10 | 09769 | 0 | 0 | 1 | 1 | |
| 83 | Washer 10.5mm Dis | 100.000.632 | 0 | 1 | 1 | 1 | |
| 84 | Rivet - Pop 0.187 Dia | MU710259 | 4 | 4 | 4 | 4 | |

PARTS LIST

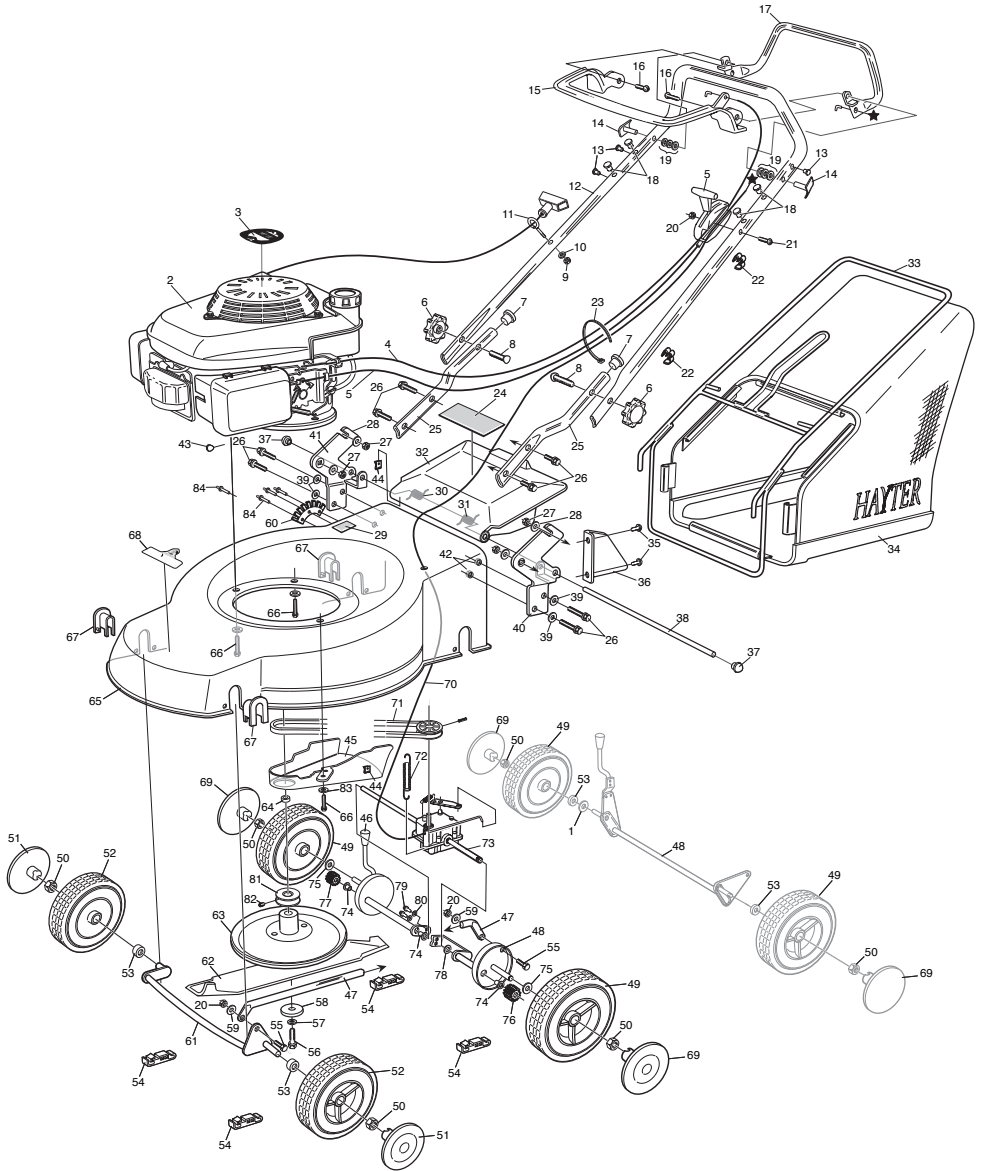

Notes:-

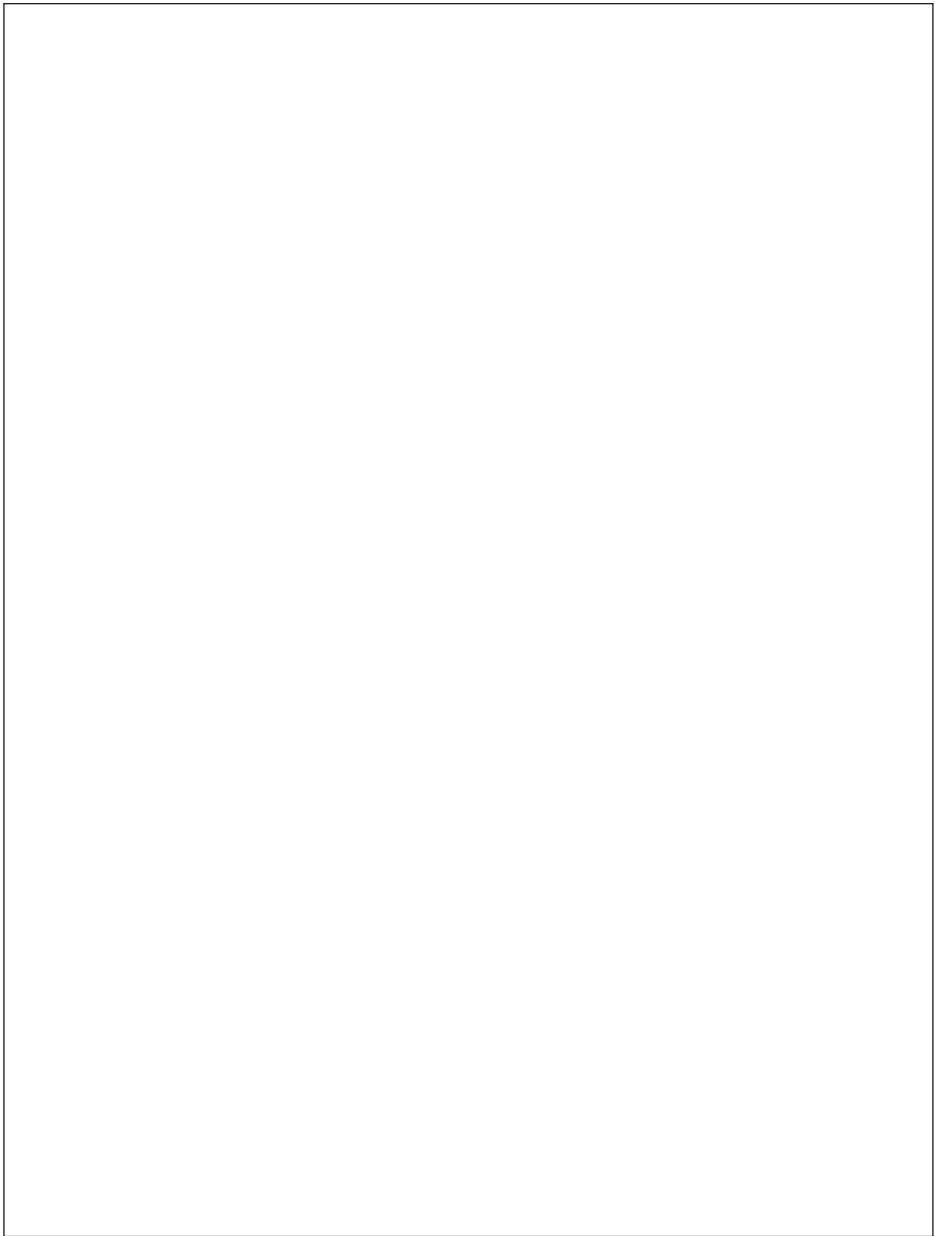

CUSTOMER INFORMATION

Serial No:

Engine Type:- GVC135EA2G7 (432/433/434) GVC160EA2G7 (435)

Engine:- Honda GVC 135 (432/433/434) 160 (435)

Date of Sale:- _____

Your Local Dealer:-

DEALER STAMP